

# RACE Newsletter

16/05/2018



ver. 6.017 build 0002

## CAR:

- **NEW** : FLASH\_0658 VAG BOSCH MED17.1.1 M&S CAN ID/W

### ATTENTION!

The new protocol FLASH\_0658 has only ID and WRITING functions, after the IDentification it is necessary to verify IF in Dimsport databank is present the corresponding certified ORI file to use for the modification. If the matching certified file does not exist in the Dimsport database you can contact Technical Support, they will check the file availability. Alternatively you can read the complete ECU (.DIM) file by New Trasdata and use the .DTF file extracted from the complete .DIM backup file.

Send the complete DIM backup file to the Race technical support for the setting file creation.

AUDI R8 (4S) 5.2L V10 40V FSI 403kW MED17.1.1  
AUDI R8 (4S) 5.2L V10 40V FSI PLUS 449kW MED17.1.1  
LAMBORGHINI HURACAN 5.2L V10 LP 610-4 449kW MED17.1.1  
LAMBORGHINI HURACAN 5.2L V10 LP 610-4 470kW MED17.1.1

- **NEW** : FLASH\_0664 GMC DELCO E86 CAN ID/W

### ATTENTION!

The new protocol FLASH\_0664 has only ID and WRITING functions, after the IDentification it is necessary to verify IF in Dimsport databank is present the corresponding certified ORI file to use for the modification. If the matching certified file does not exist in the Dimsport database you can contact Technical Support, they will check the file availability. Alternatively you can read the complete ECU (.DIM) file by New Trasdata and use the .DTF file extracted from the complete .DIM backup file.

Send the complete DIM backup file to the Race technical support for the setting file creation.

CHEVROLET SILVERADO MK3 2500HD 6.6L V8 DURAMAX 296KW DELCO E86  
CHEVROLET SILVERADO MK3 3500HD 6.6L V8 DURAMAX 250KW DELCO E86  
GMC SIERRA MK3 2500HD 6.6L V8 DURAMAX 296KW DELCO E86  
GMC SIERRA MK3 3500HD 6.6L V8 DURAMAX 296KW DELCO E86

- **NEW** : FLASH\_0678 VAG BOSCH MED17.1.62 CAN ID/W

**ATTENTION!**

The new protocol FLASH\_0678 has only ID and WRITING functions, after the IDentification it is necessary to verify if in Dimsport databank is present the corresponding certified ORI file to use for the modification. IF the matching setting file is NOT present in databank you must send the IDentification file of the vehicle to the Race Tech. Support and wait the answer. The availability of the file is not guaranteed; the Race Tech. Support reserves the right to verify.

AUDI RS3 (8V) 2.5L 16V TFSI RS 294kW MED17.1.62  
 AUDI TT (FV) 2.5L 16V TFSI RS 294kW MED17.1.62  
 VOLKSWAGEN TERAMONT 2.0L 16V TSI 220kW MED17.1.62

- **NEW** : FLASH\_0682 VAG BOSCH MED17.1.61 CAN ID/W

**ATTENTION!**

The new protocol FLASH\_0682 has only ID and WRITING functions, after the IDentification it is necessary to verify if in Dimsport databank is present the corresponding certified ORI file to use for the modification. IF the matching setting file is NOT present in databank you must send the IDentification file of the vehicle to the Race Tech. Support and wait the answer. The availability of the file is not guaranteed; the Race Tech. Support reserves the right to verify.

AUDI A4 (B9) 1.4L TFSI 110kW MED17.1.61

- **MOD** : FLASH\_0410 FORD/LR/MAZDA/TROLLER SID208/209 CAN r/w **FULL OBD2**

**ATTENTION:** the FULL OBD2 system is now available for FORD RANGER & FORD TRANSIT vehicles equipped with SID209 ECUs.

Trough the FULL OBD2 mode selection you can write via OBDII diagnostic port WITHOUT OPENING the ECU nor performing the PATCH UNLOCK with the New Trasdata.

Nevertheless, if necessary, the protocol will still support the previous OBD2+UNLOCK system that oblige to previously perform the ECU unlock via New Trasdata.

For specific info refer to the dedicated manual.

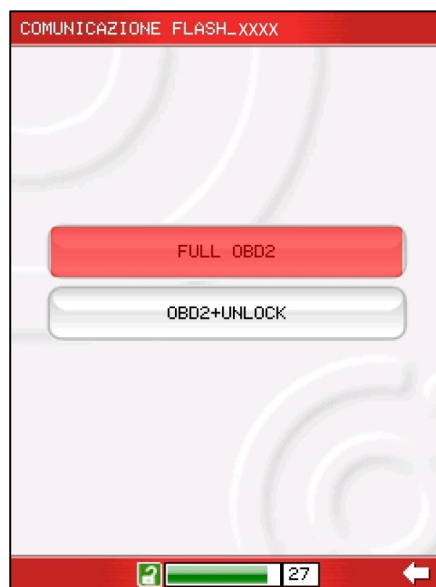

**TRUCK:**

- **NEW**: FLASH\_0679 CUMMINS – DRESSTA MOTOROLA CM850 CAN R/W

DRESSTA CRAWLER DOZERS TD-15M EXTRA 8.3L QSC 153kW CM850  
 DRESSTA CRAWLER DOZERS TD-20M EXTRA 8.3L QSC 194kW CM850

- **NEW**: FLASH\_0681 CUMMINS – KAESSBOHRER TRUCK CM2350 CAN R/W

KAESSBOHRER PB600 POLAR 828 12L 317kW CM2350A

RENESAS SH7050 CPUs:

**ATTENTION!!! NEW METAL POSITIONING FRAME ADAPTERS AVAILABLE!!**

- **F34DM036 base board for RENESAS terminal adapters**

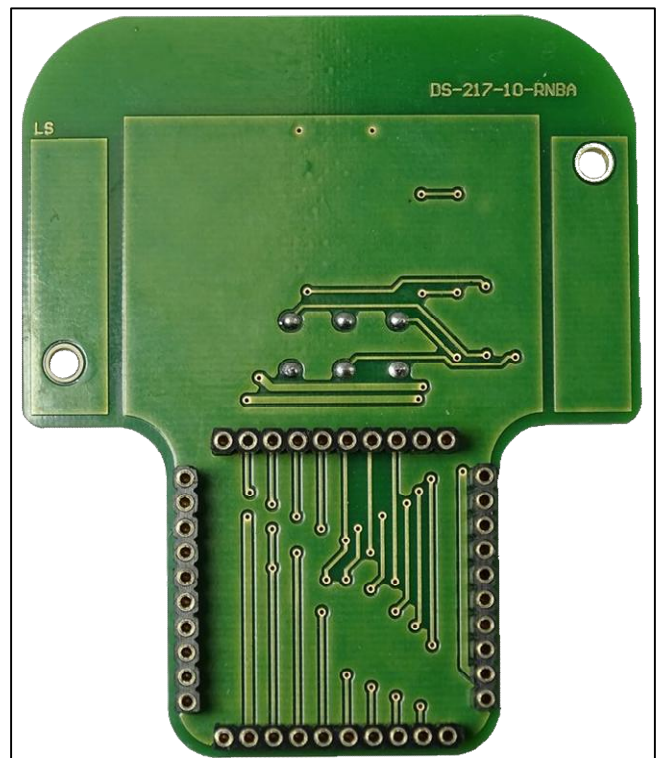
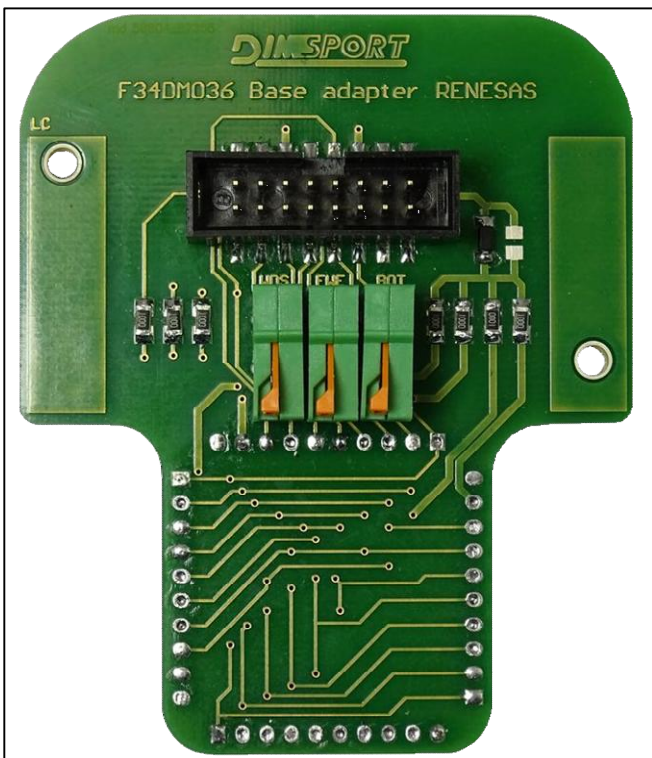

- **F34DM037 terminal adapter RENESAS SH725XX-36**

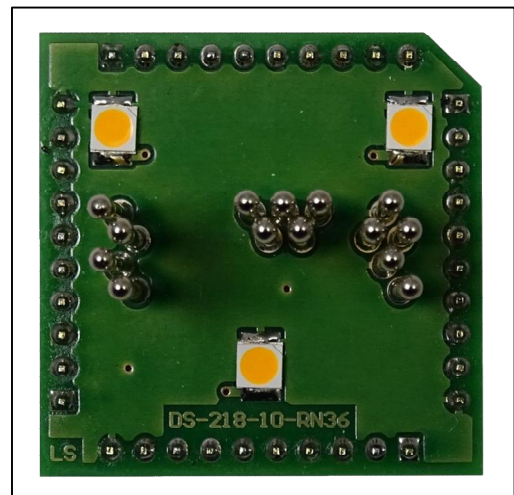
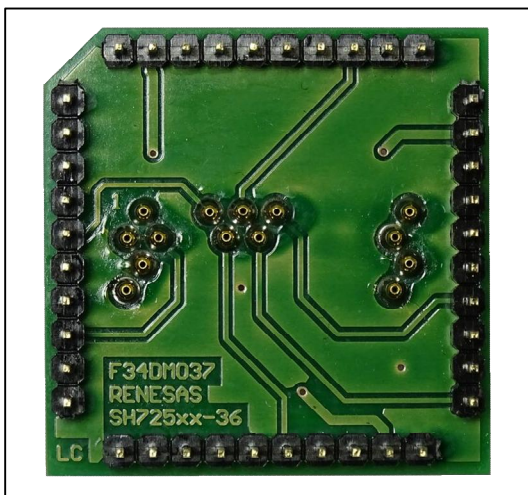



- **F34DM038 terminal adapter RENESAS SH725XX-26**

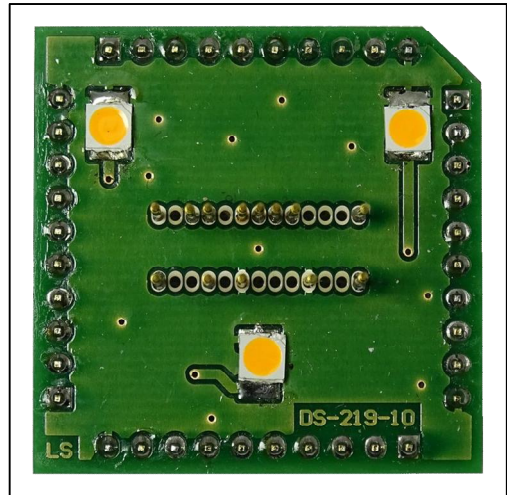
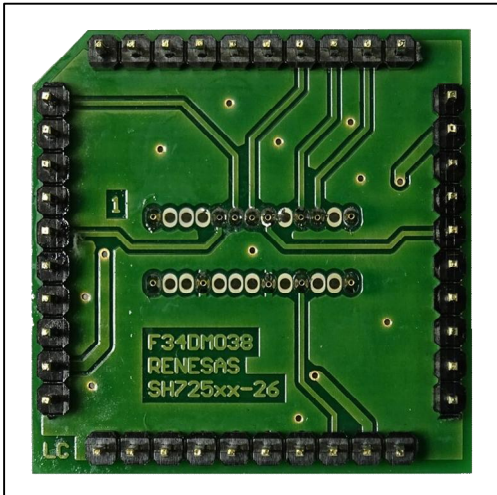

**ATTENTION!!! NEW ADAPTER AVAILABLE for SOLDERED CONNECTION!!!**

- **F34NTA21 soldered connection adapter for RENESAS**

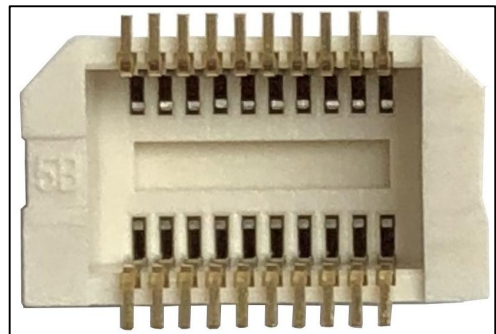
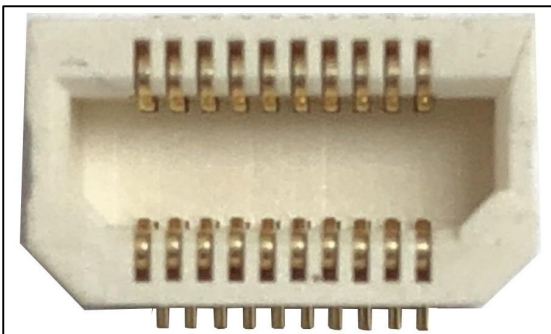
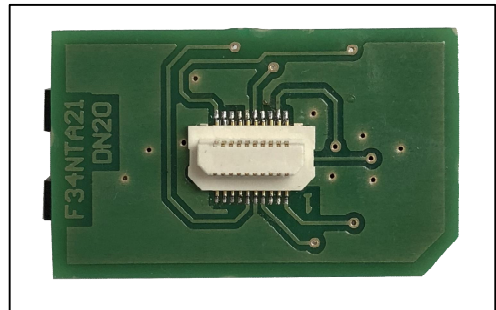
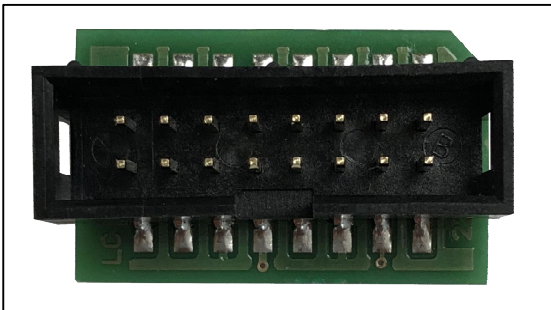

**NEW : 59 - RENESAS SH725XX JTAG**

TRANSTRON L4.3 SH72533 ISUZU Diesel

**NEW** - plugin 1043 – ISUZU V-MAX/D-MAX (RT50,RT85) 2.5L TDI DOHC 85/100kW SH72533  
ISUZU V-MAX/D-MAX (RT50,RT85) 3.0L TDI DOHC 120/130kW SH72533  
ISUZU KB 250 2.5L 16V D-TEQ 85kW SH72533  
ISUZU KB 300 3.0L 16V D-TEQ 130kW SH72533  
ISUZU MU-X 3.0L 16V TDI DOHC 130kW SH72533  
ISUZU V-CROSS 3.0L 16V dDI VGS 130kW SH72533

CNH 1851862-30 SH72531 CNH Diesel

**NEW** - plugin 1044 – NEW HOLLAND CONSTRUCTION  
SKID STEER LOADERS L220 2.2L TDI DOHC 48kW SH72533

DELPHI DCM3.7 SH72513 VAG Diesel

**NEW** - plugin 1045 – VOLKSWAGEN POLO 5 (6R,6C) 1.2L 12V TDI 55kW DCM3.7  
SEAT IBIZA Mk4 (6J) 1.2L 12V TDI 55kW DCM3.7  
SKODA FABIA Mk2 (5J) 1.2L 12V TDI 55kW DCM3.7  
SKODA ROOMSTER 1.2L 12V TDI 55kW DCM3.7  
SKODA PRAKTIK 1.2L 12V TDI 55kW DCM3.7

DELPHI DCM3.7 SH72544R GM Opel Diesel

**NEW** - plugin 1046 – OPEL ANTARA 2.2L 16V CDTI 2WD 120kW DCM3.7  
OPEL ANTARA 2.2L 16V CDTI 4WD 135kW DCM3.7  
CHEVROLET CAPTIVA 2011 2.0L 16V VCDi 2WD 110kW DCM3.7  
CHEVROLET CAPTIVA 2011 2.2L 16V VCDi 2WD 120kW DCM3.7  
CHEVROLET CAPTIVA 2011 2.0L 16V VCDi 4WD 135kW DCM3.7  
CHEVROLET CRUZE 2.0L 16V VCDi 120kW DCM3.7  
CHEVROLET ORLANDO 2.0L 16V CRDi 96/120kW DCM3.7

DENSO MB279700-9500 SH72543R Volvo Petrol

**NEW** - plugin 1047 – VOLVO S60 Mk2 3.0L 24V T6 R-Design 242kW DENSO

DENSO MB279700-9621 SH72546 Volvo Diesel

**NEW** - plugin 1048 – VOLVO V40 Mk2 2.0L 16V D2 88kW DENSO  
VOLVO V60 Mk2 2.0L 16V D2 88kW DENSO  
VOLVO S60 Mk2 2.0L 16V D2 88kW DENSO

CONTINENTAL VD46.1 SH72546 PSA Petrol

**NEW** - plugin 1049 – PEUGEOT 308 (T9) 1.2L 12V e-THP 96kW CONTINENTAL

DELPHI DCM3.3 SH72544R JCB Diesel

**NEW** - plugin 1050 – JCB TELEHANDLER 536-60 AGRI 4.4L 93kW DCM3.3  
JCB TELEHANDLER 536-70 AGRI 4.4L 55kW DCM3.3

DENSO 1J524-59052 SH72543R KUBOTA Diesel

**NEW** - plugin 1051 – KUBOTA AGRICULTURE M SERIES 5111 3.8L 84kW DENSO

DELPHI DCM3.7 SH72543R VAG Diesel

**NEW** - plugin 1053 – VOLKSWAGEN POLO 5 (6R,6C) 1.2L 12V TDI 55kW DCM3.7  
SEAT IBIZA Mk4 (6J) 1.2L 12V TDI 55kW DCM3.7  
SKODA FABIA Mk2 (5J) 1.2L 12V TDI 55kW DCM3.7  
SKODA ROOMSTER 1.2L 12V TDI 55kW DCM3.7  
SKODA PRAKTIK 1.2L 12V TDI 55kW DCM3.7

DENSO 112700-1416 SH72531 TOYOTA Petrol

**NEW** - plugin 1054 – TOYOTA GT86 2.0L 16V DOHC 147kW DENSO  
SUBARU BRZ 2.0L 16V DOHC 147kW DENSO  
SUBARU CROSSTREK 2.0L 16V 110kW DENSO  
SUBARU OUTBACK 2015 2.5L 16V 129kW DENSO  
SUBARU EXIGA CROSSOVER 7 2.5L 16V 129kW DENSO

VALEO V50 SH72543R RENAULT Petrol

**NEW** - plugin 1055 –RENAULT CAPTUR 0.9L 12V TCe 67kW Valeo V50  
RENAULT CLIO 4 0.9L 12V TCe 66kW Valeo V50  
DACIA LOGAN II 0.9L 12V TCe 66kW Valeo V50  
DACIA SANDERO 0.9L 12V TCe 66kW Valeo V50

HITACHI DEF003 SH72543R SUBARU Petrol

**NEW** - plugin 1056 –SUBARU IMPREZA III 2.0L WRX DIT 200kW HITACHI  
SUBARU LEVORG 1.6L 16V DIT 125kW HITACHI

DENSO 112731-4420 SH72531 DAIHATSU Petrol

**NEW** - plugin 1075 –DAIHATSU COPEN Mk2 0.7L 16V turbo DOHC 47kW DENSO

DENSO 275722-5130 SH72543R MAZDA Diesel

**NEW** - plugin 1078 –MAZDA 3 (BL) 2.2L 16V SKYACTIV-D 110kW DENSO  
MAZDA 3 (BM) 2.2L 16V SKYACTIV-D 110kW DENSO  
MAZDA 6 (GJ) 2.2L 16V SKYACTIV-D 110/129kW DENSO  
MAZDA CX-5 2.2L 16V SKYACTIV-D 110/129kW DENSO

DENSO MB279700-9621 SH72546 VOLVO Petrol

**NEW** - plugin 1079 –VOLVO V40 Mk2 1.5L 16V T2 90kW DENSO

DENSO 275722-4810 SH72543R SUBARU Diesel

**NEW** - plugin 1081 –SUBARU FORESTER SJ Mk4 2.0L 16V D 108kW DENSO  
SUBARU OUTBACK 2015 2.0L 16V D 110kW DENSO  
SUBARU XV2.0L 16V D 108kW DENSO

TRANSTRON SH72544 ISUZU Diesel

**NEW** - plugin 1082 –ISUZU N SERIES N35 3.0L 16V TDi DOHC 88kW TRANSTRON  
ISUZU N SERIES L35 3.0L 16V TDi DOHC 88kW TRANSTRON  
ISUZU NPR-NQR-MRR 5.2L 4L TDI 140kW TRANSTRON  
ISUZU V-MAX/D-MAX (RT50,RT85) 2.5L TDI DOHC 100/120kW TRANSTRON

## **INFINEON TRICORE CPUs:**

**ADD : 03 - INFINEON TRICORE NO PSW CANLINE**

Continental-Siemens-VDO SIM2K-241 5WY4Yxxx #R TC1738 Hyundai/Kia Transmission

**NEW** – plugin 1076 – HYUNDAI i35 (MD) 1.8L 16V 110kW SIM2K-241 #R  
HYUNDAI i45 (YF) 1.8L 16V 110kW SIM2K-241 # R  
HYUNDAI ELANTRA (MD) 1.8L 16V 110kW SIM2K-241 # R  
HYUNDAI AVANTE (MD) 1.8L 16V 110kW SIM2K-241 # R  
KIA SPORTAGE (SL) 1.8L 16V 110kW SIM2K-241 # R

Continental-Siemens-VDO SIM2K-341 TC1738 Hyundai/Kia Transmission

**NEW** – plugin 1077 – HYUNDAI AZERA (HG) MY2014 3.3L 24V V6 GDi 218kW SIM2K-341

**NEW : 60 - INFINEON TRICORE CONTINENTAL SIM2Kxxx TPROT HYUNDAI\_KIA**

Continental-Siemens-VDO SIM2K-241 5WY4Yxxx #L TC1767 Hyundai/Kia Petrol

**NEW** – plugin 1058 – HYUNDAI i35 (MD) 1.8L 16V 110kW SIM2K-241 #L  
HYUNDAI i45 (YF) 1.8L 16V 110kW SIM2K-241 #L  
HYUNDAI ELANTRA (MD) 1.8L 16V 110kW SIM2K-241 #L  
HYUNDAI AVANTE (MD) 1.8L 16V 110kW SIM2K-241 #L  
KIA SPORTAGE (SL) 1.8L 16V 110kW SIM2K-241 #L

Continental-Siemens-VDO SIM2K-305 TC1782 Hyundai/Kia Transmission

**NEW** – plugin 1059 – HYUNDAI ELANTRA (AD) 1.6L 16V T-GDI 130kW SIM2K-305

Continental-Siemens-VDO SIM2K-260 TC1791/TC1793 Hyundai/Kia Petrol

**NEW** – plugin 1060 – KIA STINGER 3.3L 24V V6 T-GDI 272kW SIM2K-260  
GENESIS G70 3.3L 24V V6 T-GDI 272kW SIM2K-260  
GENESIS G80 Sports 3.3L 24V V6 T-GDI 272kW SIM2K-260  
GENESIS G90 3.3L 24V V6 T-GDI 272kW SIM2K-260

### RENESAS M32R CPUs:

ADD : 17 - RENESAS M32R

DENSO 32920-17KXX M32R196 SUZUKI Petrol Micro traction control management

NEW - plugin 1061 – SUZUKY MOTORCYCLES MY2017 GSX-R1000 1.0L 149kW DENSO

DENSO 32920-17KXX M32R196 SUZUKI Petrol Micro engine management

NEW - plugin 1062 – SUZUKY MOTORCYCLES MY2017 GSX-R1000 1.0L 149kW DENSO

### NEC CPUs:

ADD : 36 - NEC NBD

DENSO 270536-1150 NEC 76F0039GD TOYOTA Petrol

NEW - plugin 1069 – TOYOTA YARIS (P1) 1.5L 16V VVT-i 78kW DENSO

DENSO 270536-5280 NEC 76F0085 TOYOTA Petrol

NEW - plugin 1080 – TOYOTA IQ (J10) 1.3L 16V VVT-i 72kW DENSO

### FREESCALE ST MPC56XX SPC56X CPUs:

ADD : 37 – FREESCALE ST MPC56XX SPC56X

CAT A5X12I1 MPC5674F Diesel

NEW – plugin 1071 – ORVEX LT 100H 4.4L 93kW A5X12I1

## NEW : PLUG-IN

PLG ID	ECU Brand	ECU Model	Brand	Connection Type	Micro	Flash Ext	Category
1043	Transtron	L4.3	ISUZU	59 - RENESAS SH725XX JTAG	SH72533		CAR
1044	CNH	1851862-30	CNH	59 - RENESAS SH725XX JTAG	SH72531		TRACTOR
1045	Delphi	DCM3.7	VAG	59 - RENESAS SH725XX JTAG	SH72513		CAR
1046	Delphi	DCM3.7	GM Opel	59 - RENESAS SH725XX JTAG	SH72544R		CAR
1047	Denso	MB279700-9500	Volvo	59 - RENESAS SH725XX JTAG	SH72543R		CAR
1048	Denso	MB279700-9621	Volvo	59 - RENESAS SH725XX JTAG	SH72546		CAR
1049	Continental	VD46.1	PSA	59 - RENESAS SH725XX JTAG	SH72546		CAR
1050	Delphi	DCM3.3	JCB	59 - RENESAS SH725XX JTAG	SH72544R		TRACTOR
1051	Denso	1J524-59052	KUBOTA	59 - RENESAS SH725XX JTAG	SH72543R		TRACTOR
1053	Delphi	DCM3.7	VAG	59 - RENESAS SH725XX JTAG	SH72543R		CAR
1054	Denso	112700-1416	TOYOTA	59 - RENESAS SH725XX JTAG	SH72531		CAR
1055	Valeo	V50	Renault	59 - RENESAS SH725XX JTAG	SH72543R		CAR
1056	Hitachi	DEF003	SUBARU	59 - RENESAS SH725XX JTAG	SH72543R		CAR
1058	Continental-Siemens-VDO	SIM2K-241 5WY4Yxxx #L	Hyundai/Kia	60 - INFINEON TRICORE CONTINENTAL SIM2K	TC1767		CAR
1059	Continental-Siemens-VDO	SIM2K-305	Hyundai/Kia	60 - INFINEON TRICORE CONTINENTAL SIM2K	TC1782		CAR
1060	Continental-Siemens-VDO	SIM2K-260	Hyundai/Kia	60 - INFINEON TRICORE CONTINENTAL SIM2K	TC1791/TC1793		CAR
1061	Denso	32920-17Kxx	Suzuki	17 - RENESAS M32R	M32R196		BIKE
1062	Denso	32920-17Kxx	Suzuki	17 - RENESAS M32R	M32R196		BIKE
1069	Denso	275036-1150	Toyota	36 - NEC NBD	76F0039GD		CAR
1071	CAT	A5X1211	Caterpillar	37 - FREESCALE/ST MPC56XX/SPC56X JTAG	MPC5674F		TRACTOR
1075	Denso	112731-4420	Daihatsu	59 - RENESAS SH725XX JTAG	SH72531		CAR
1076	Continental-Siemens-VDO	SIM2K-241 5WY4Yxxx #R	Hyundai/Kia	03 - INFINEON TRICORE NO PSW CANLINE	TC1738		CAR
1077	Continental-Siemens-VDO	SIM2K-341	Hyundai/Kia	03 - INFINEON TRICORE NO PSW CANLINE	TC1738		CAR
1078	Denso	275722-5130	Mazda	59 - RENESAS SH725XX JTAG	SH72543R		CAR
1079	Denso	MB279700-9621	Volvo	59 - RENESAS SH725XX JTAG	SH72546		CAR
1080	Denso	275036-5280	Toyota	36 - NEC NBD	76F0085		CAR
1081	Denso	275722-4810	Subaru	59 - RENESAS SH725XX JTAG	SH72543R		CAR
1082	Transtron	SH72544R	Isuzu	59 - RENESAS SH725XX JTAG	SH72544R		CAR

### DIMSPORT S.r.l.

Località San Iorio, 8-B - Zona Industriale Madonna  
15020 SERRALUNGA DI CREA (AL) – ITALY  
P.IVA 01889630065

Tel. +39.0142.9552  
Fax +39.0142.940094

[info@dimSPORT.it](mailto:info@dimSPORT.it)

[support.race@dimSPORT.it](mailto:support.race@dimSPORT.it)

[www.dimSPORT.it](http://www.dimSPORT.it)